

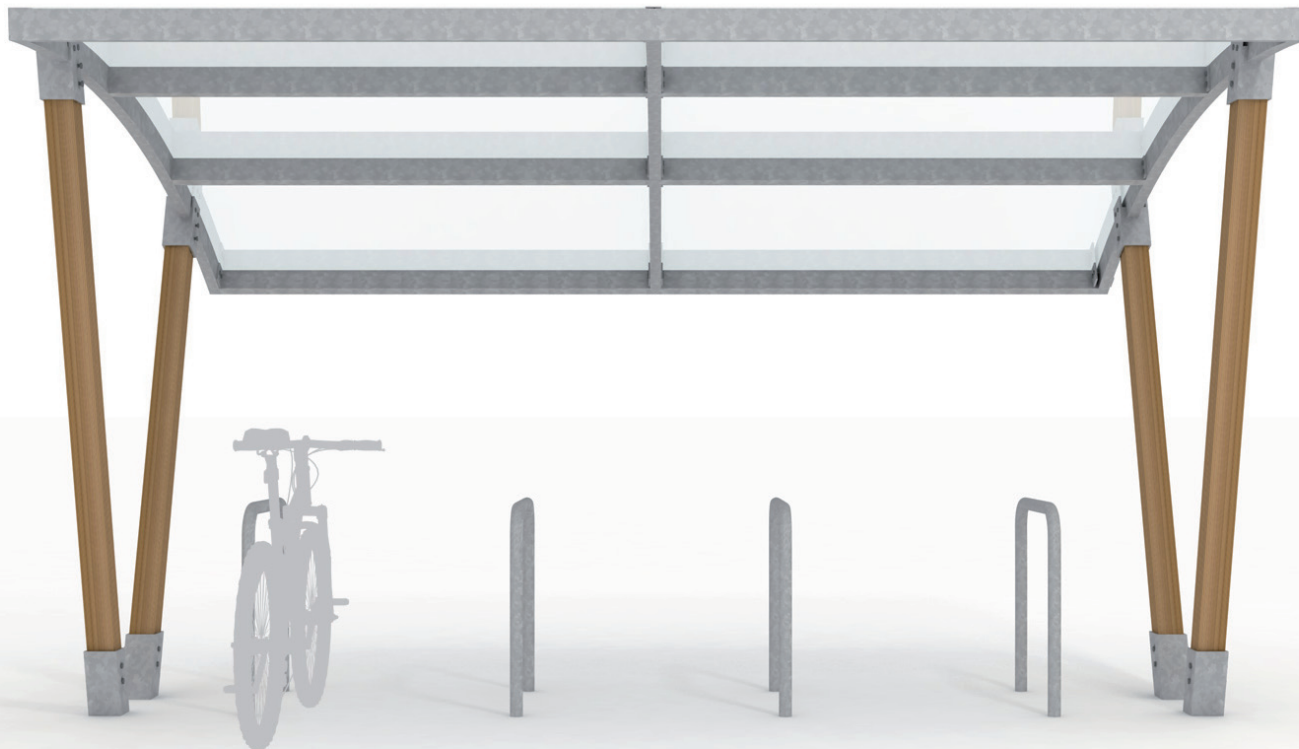

arcrange.

high quality modular bike shelter
range, designed and manufactured
by make me cycleshelters



contents.

1. Overview
2. Modular system
3. Dimensions
4. Finishes & fixings
5. Cycle racks and hoops
7. Contact

overview.

Our arc range has been designed to combine materials to create a cycle shelter which is an addition to an external space providing an aesthetically sound solution to bike or cycle storage. We use FSC timbers such as European Oak or Iroko with low maintenance requirements as standard and metalwork is fabricated from mild steel with a galvanised coating, we can also powder coat to practically any RAL colour.

As with all our bike shelters, we can supply various sizes of shelters to cater for varying environments from university cycle storage to children's bike rack canopies – our designs are supplied in modular units which enable you to start of small according to your budget and then increase your cycle shelters over time to create a large cycle compound.

Cycle racks used within all our bike shelters are available as single standalone hoops or racks, surface mounted or below ground fixed. Bike storage racks can either be individual or supplied welded together resulting in less time on site during assembly. Cycle racks used within the cycle shelter can be supplied from stock sizes or custom fabricated to suit a particular requirement for bike storage.

Our orders are supplied flat packed and predrilled to make assembly as easy as possible, we can either supply assembly instructions for your own self assembly or our installation team can come to site and fit on your behalf.

Our designers can create 3D visuals of alternative cycle storage shelter designs if you have a particular idea in mind, we're here to help so just get in contact...



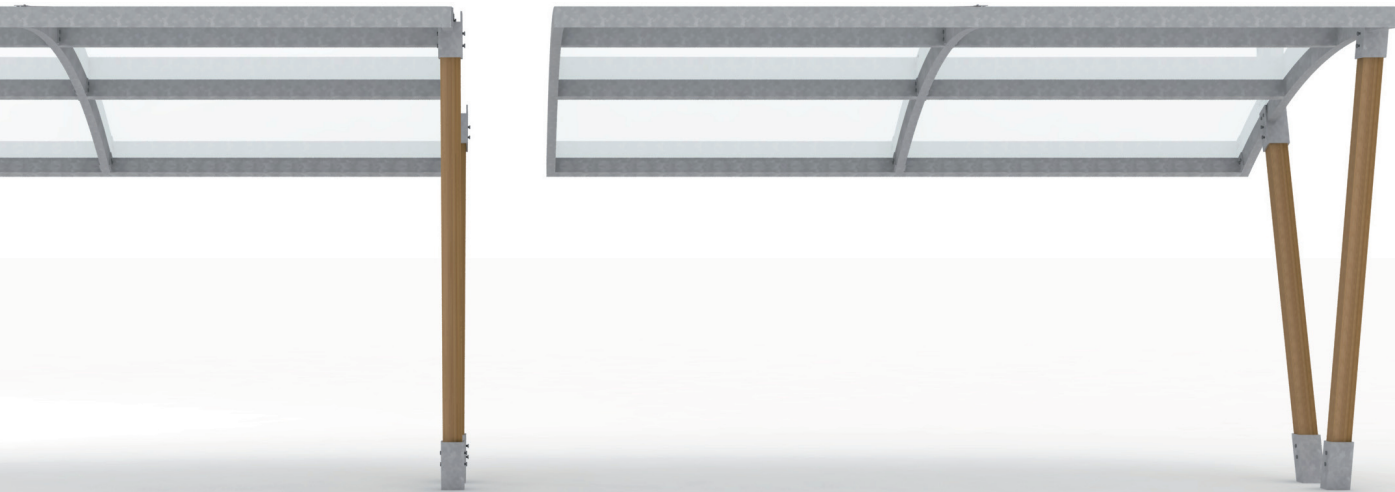

modular system

All our cycle parking products are designed to be modular. Our arc timber bike shelter standard module provides covered storage for 10 bikes right up to a large cycle compound with several shelters interlocked to create a single run for multiple bike storage.

Cycle racks used within the cycle or bike shelter can be supplied as single standalone hoops or racks, or multiple 'toast' cycle racks. We are also happy to manufacture to all BREEAM specifications, essentially we can design and manufacture whatever you require.

Our modular design for the ARC cycle shelter range means that you can start off with an initial module and then as your cycle parking needs grow you can then purchase additional add-on units. Each starter module stores up to 10 bicycles using a floor fixed multiple or 'toast' cycle rack in a finish to suit the metalwork to the roof canopy.

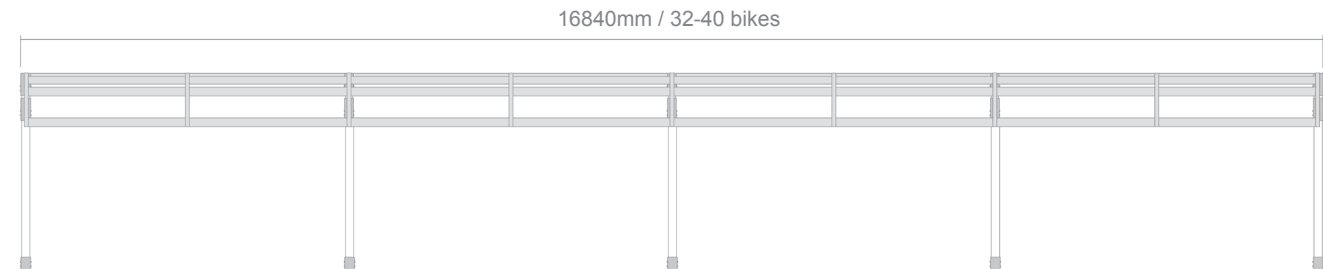
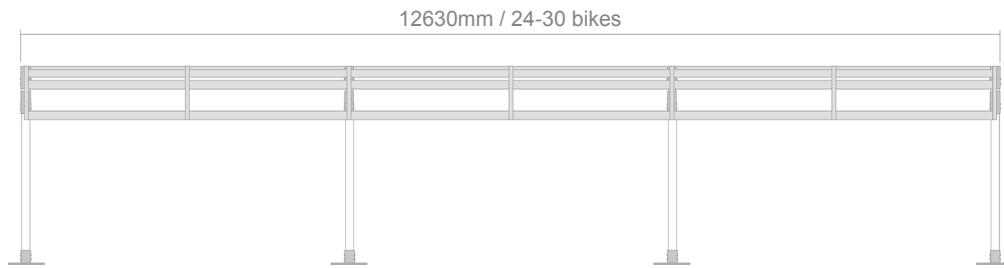
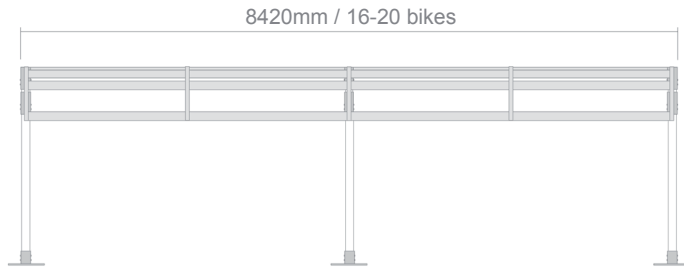
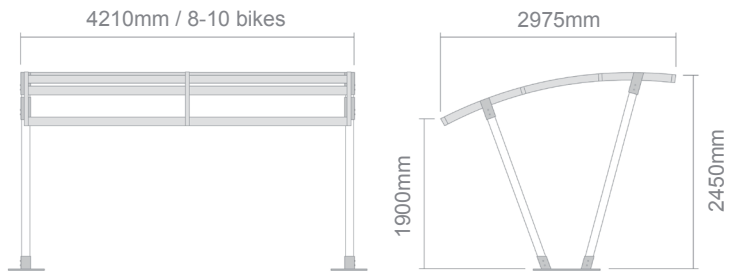

dimensions.

The arc range of cycle shelters start with an initial module at just over 4 metres wide and can span up to any width required dependant on the number of bike storage racks used with the shelter.

The sizes shown represent the most popular sizes, if you have a particular size in mind or wish to use the cycle shelter for alternative storage then just get in contact and our designers will help you work up a viable solution to your needs.

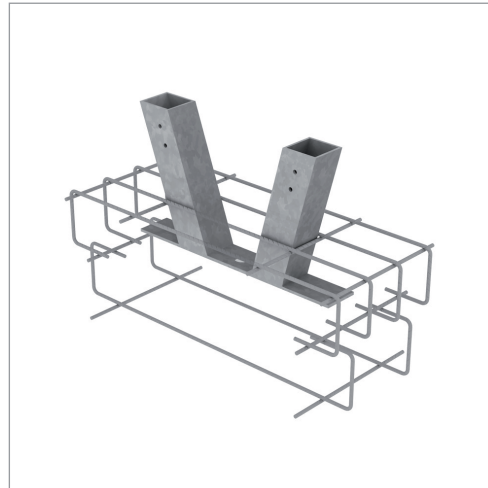

finishes.

The arc range of cycle storage shelters are primarily supplied with a mild steel galvanised frame with FSC European Oak timber uprights. All timber used is planed to have smooth rounded edges for safety and oiled with Danish Oil to help bring out the grain and protect from weathering.

Galvanising is carried out in accordance with BS EN ISO 1461:2009.

The roof is clad using clear polycarbonate sheeting allowing light to pass through into the shelter whilst the UV protection within the sheet helps prevent yellowing of the panels over time.

fixings.

The arc range shelters are available is either below ground or above ground fixed.

The below ground option uses a rebar cage which requires setting into concrete (we supply a simple jig to make the setting out of this easier).

The above ground fixed option uses a large base plate and through bolts to fix down into the concrete surface.

Our cycle shelters are all available as self assembly flat packed units or we can install the shelters on your behalf.

cycle rack a.**cycle rack b.****cycle rack c.****cycle racks & hoops.**

We have a range of cycle racks or bicycle stands for use within our shelters, ideal for bike storage use in schools, universities and workplaces. Whether you're looking for a standalone secure bike stand to use outdoors or a series of cycle stands to use within a cycle shelter or large compound, we have the solutions for you. Cycle hoops and racks can either be above ground or below ground fixed.

Our designs for single bike storage and multiple bike storage come in different shapes and sizes, all our bike racks are manufactured in the UK using:

- Galvanised mild steel framework as standard
- Optional powder coated frames in RAL colours, any colour included in the price
- Supplied with standard through bolts for floor fixing to concrete

contact.

make me ltd

The barn
Manor Lodge
Silver Street
South Petherton

t 0845 305 8120

e hello@mm-cycleshelters.co.uk

Company reg number 6839031
VAT reg number 973 1344 18

